

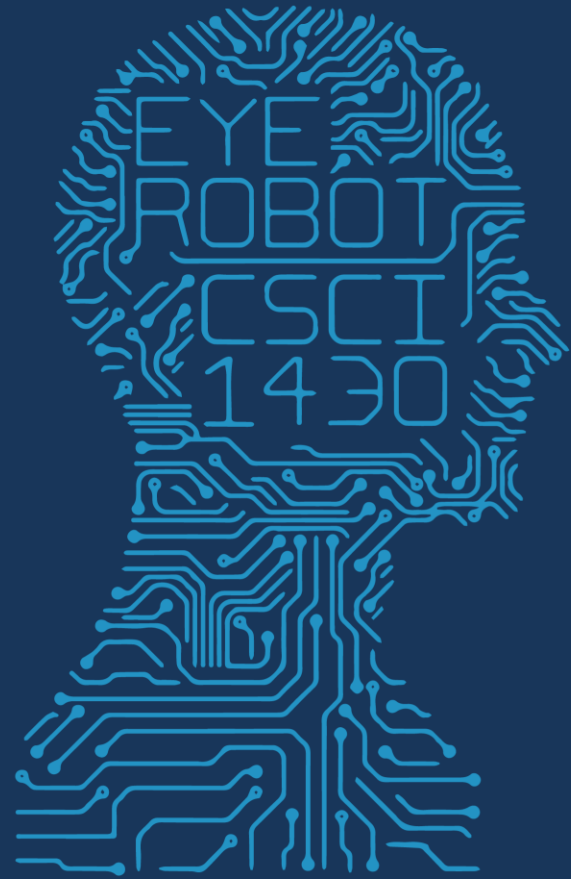

1950

FUTURE VISION



17 APRIL 2019

COMPUTER VISION

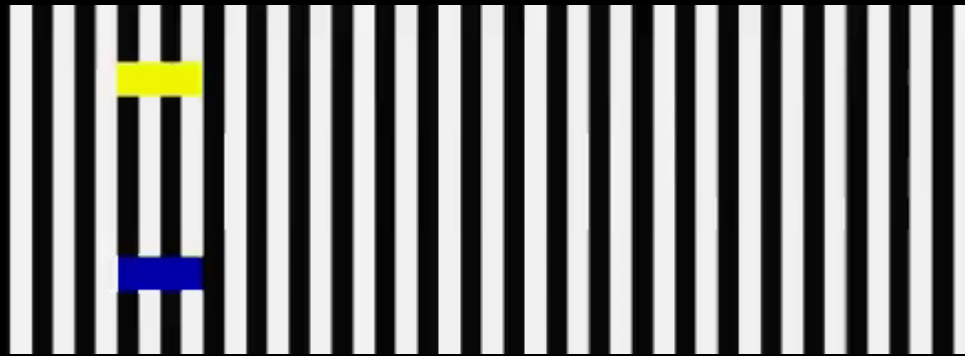

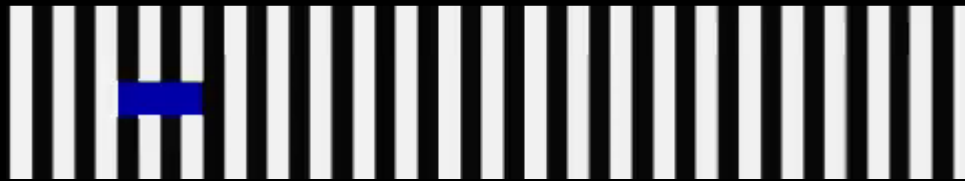

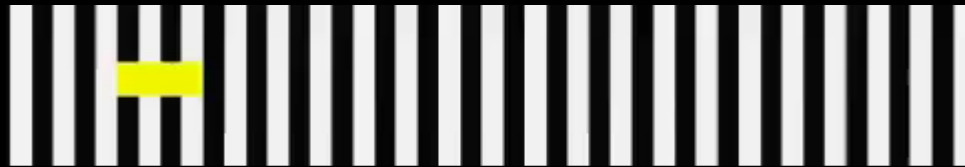

<https://scratch.mit.edu/projects/188838060/>

Demo

Real-Time Human Pose Recognition in Parts from Single Depth Images

Jamie Shotton et al. (MS Research & Xbox Incubation)

CVPR 2011

Slides by YoungSun Kwon

<http://sglab.kaist.ac.kr/~sungeui/IR/Presentation/first/20143050권용선.pdf>

2014. 11. 11

Background

- **Motion Capture (Mocap)**
 - **Capture a motion** from sensors attached to human body



<http://www.neogaf.com/forum/showthread.php?t=824332>

Background

- Pose Recognition
 - **Estimate a pose** from images and make a skeletal model

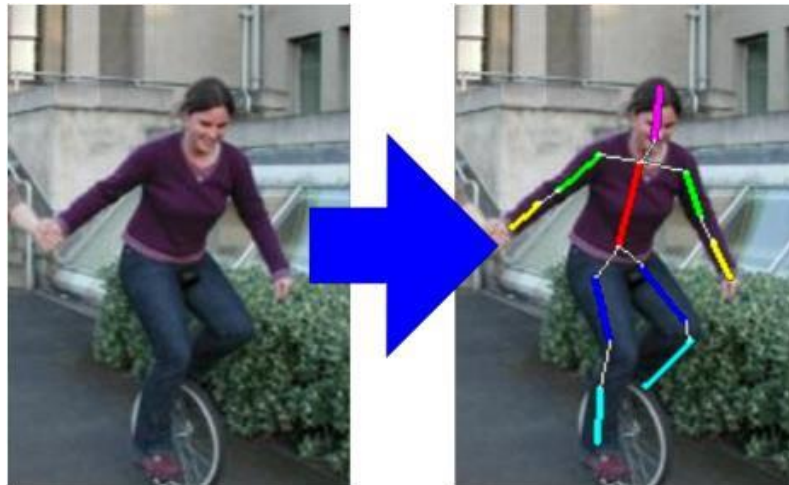

<http://www.vision.ee.ethz.ch/~hpedemo/fullhpedemo.png>



<http://www.youtube.com/watch?v=Y-iKWe-U9bY>

Background

- **Depth Image**
 - Each pixel has **distance** information, instead of RGB



RGB Image



RGB Camera



Depth Image



Depth Camera

Why this paper?

- **Main Contribution**

- Convert **pose recognition** problem to **classification** problem
 - One of application for image retrieval technique



No constraint, More General

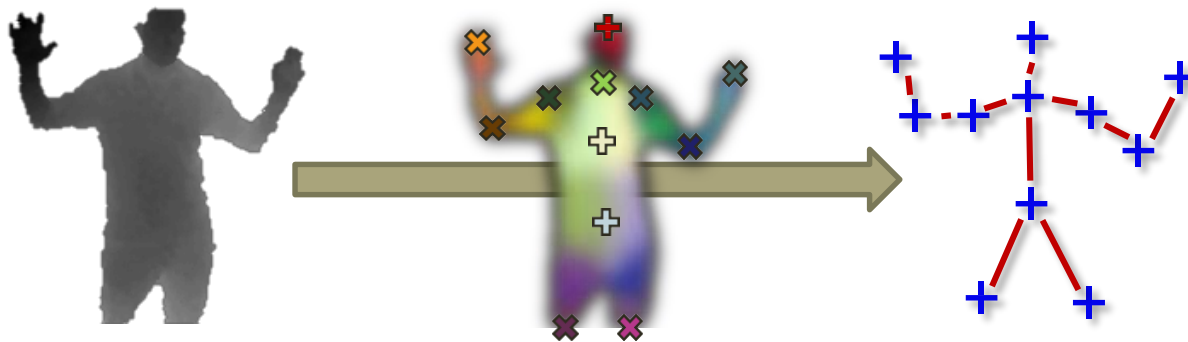

Overview

- **Overview**

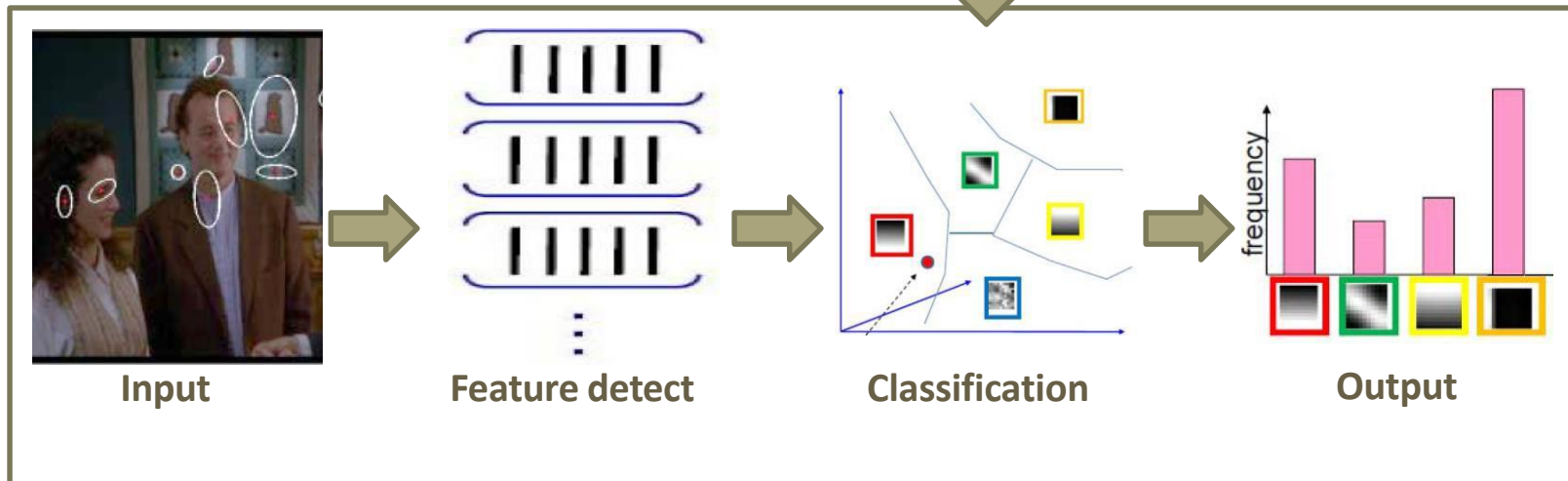
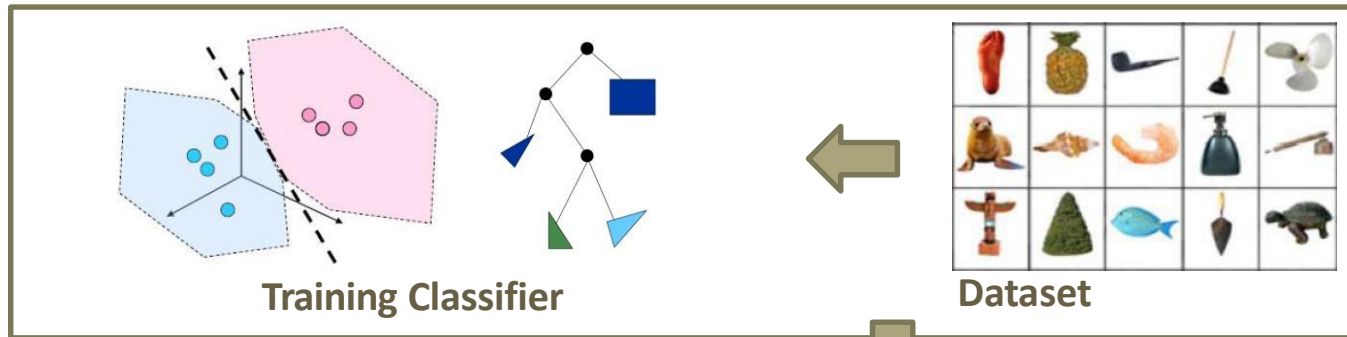

Overview

- **Overview**

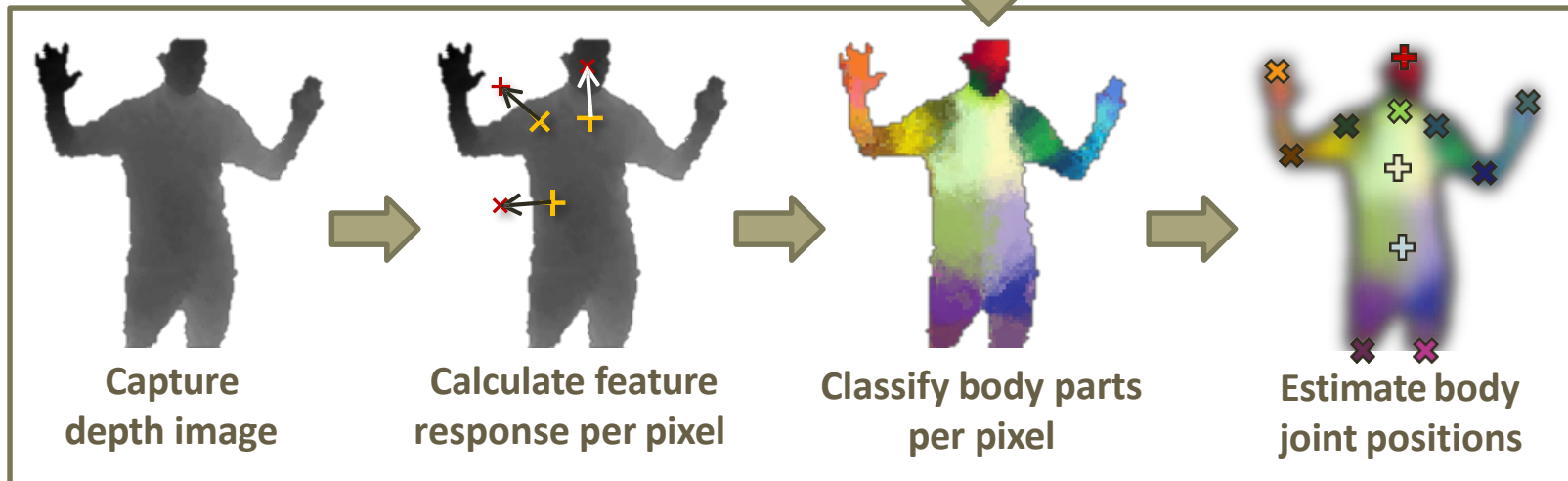
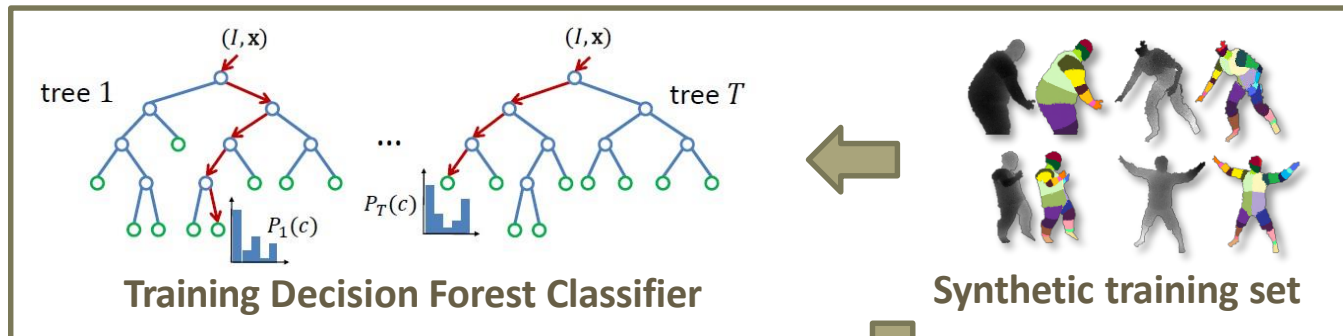

Body Part Representation

- **31 body parts (classes)**
 - LU/RU/LW/RW head
 - Neck
 - L/R shoulder
 - LU/RU/LW/RW arm
 - L/R elbow
 - L/R wrist
 - L/R hand
 - LU/RU/LW/RW torso
 - LU/RU/LW/RW leg
 - L/R knee
 - L/R ankle
 - L/R foot

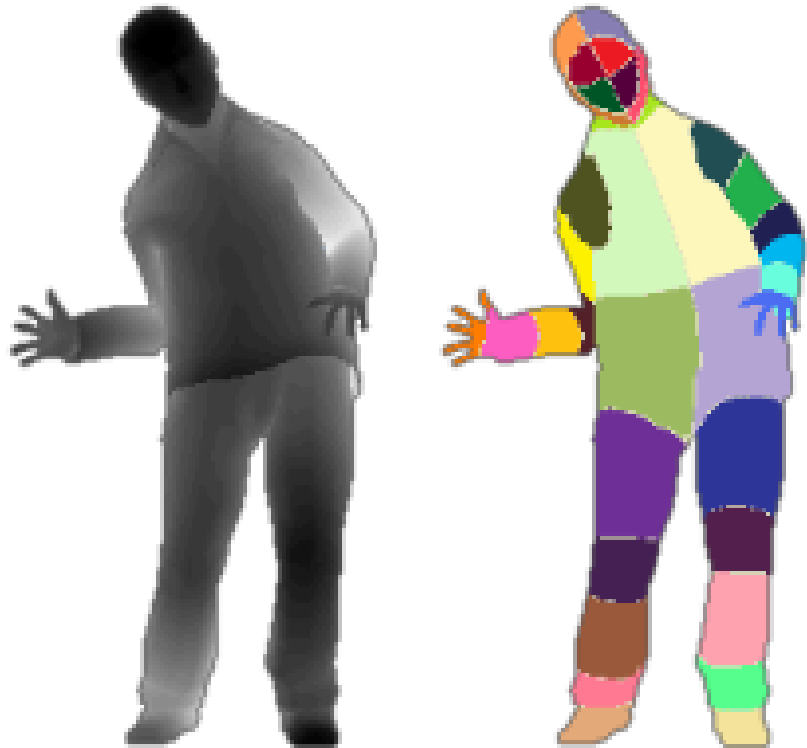

Synthetic dataset

- **To account for variations in real world**
 - Rotation & Translation, Hair, Clothing, Height, Camera Pose, etc...
- **Large scale and variety**

Record **motion captures**
500K frames and
extract **100K poses** among these

Create **several models**
with variations



Render (depth, body parts) pairs



Depth Image Feature Comparison

Calculate feature response for each pixel

Feature Response Function

$$f(I, \mathbf{x}) = d_I(\mathbf{x}) - d_I(\mathbf{x} + \Delta)$$

image depth offset depth

pixel

- Δ is chosen in training step randomly
- For example
 - $\Delta_1 = (0, 1)$ $\Delta_3 = (-1, 0)$
 - $f(I, \mathbf{x} | \Delta_1)$ has small value
 - $f(I, \mathbf{x} | \Delta_3)$ has large value
- Can be trained in parallel on GPUs

Input depth image

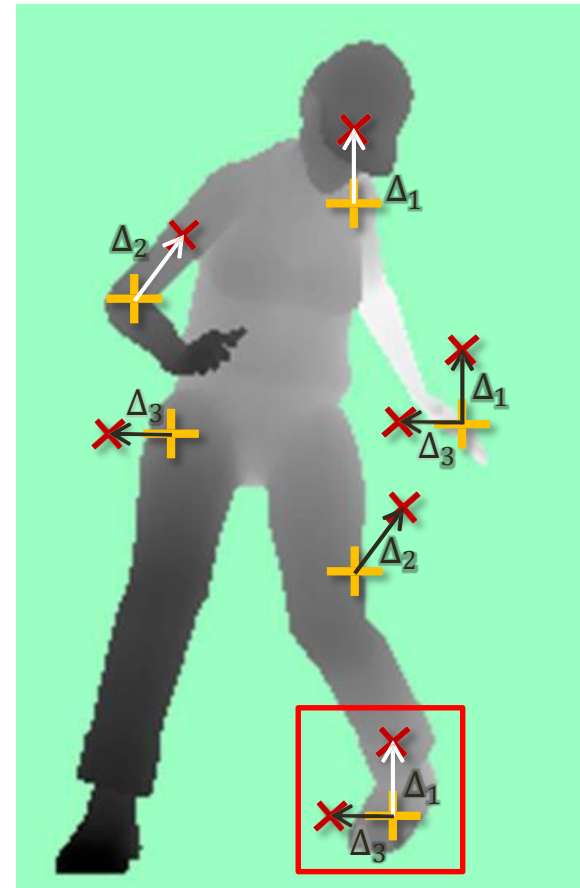

Decision tree classifier

- Remember Viola-Jones face detector?
- Example of classification for hand(H) or foot(F)

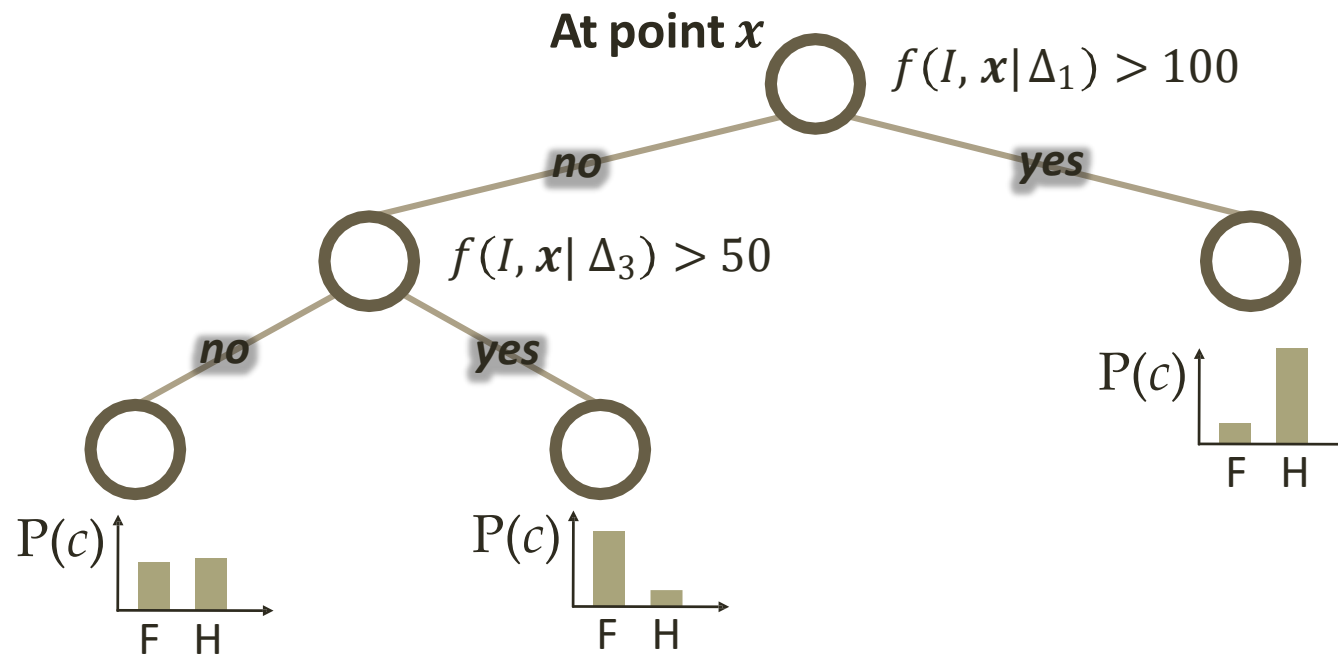
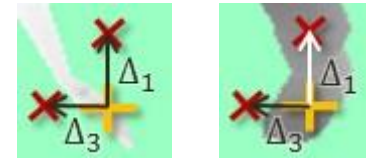

4 T. Amit et al., Shape quantization and recognition with randomized trees, Neural Computation, 1997

5 L. Breiman, Random forests, Mach. Learning, 2001

6 F. Moosmann et al., Fast discriminative visual codebooks using randomized clustering forests, NIPS, 2006

Decision Forest Classifier

- In training step, Δ is chosen randomly
- Generate *many trees* to build a decision forest
- In testing step, check all trees and compute average probability

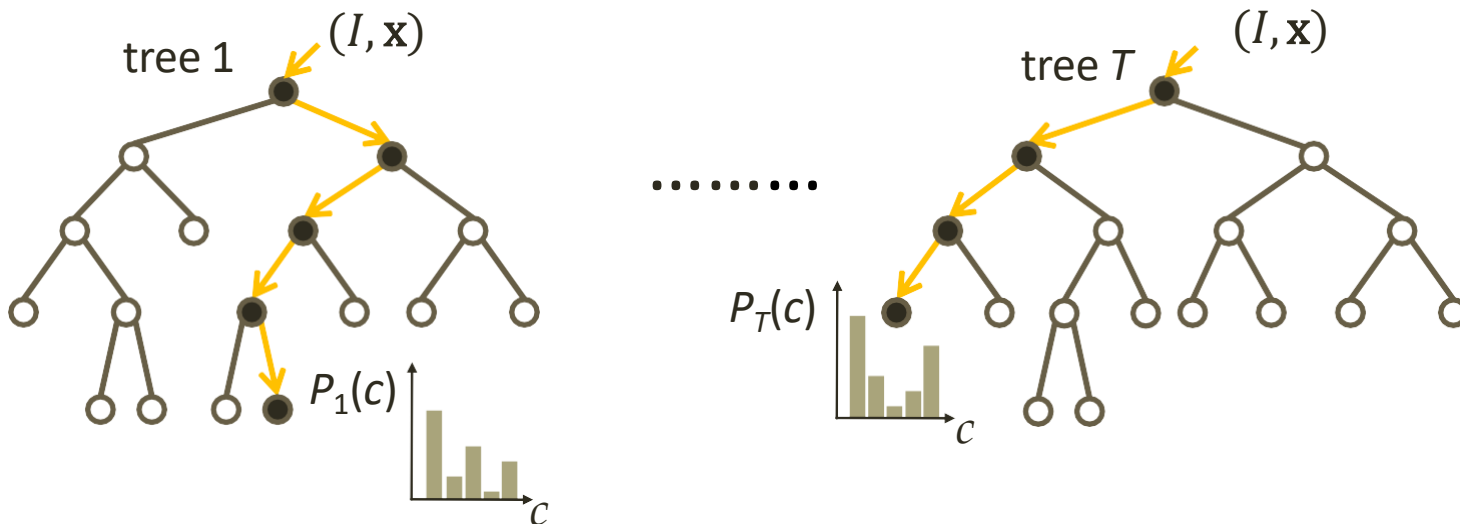

$$P(c|I, \mathbf{x}) = \frac{1}{T} \sum_t^T P_t(x, I|c)$$

But...normalized in depth

$$\frac{1}{d_I(\mathbf{x})} \bullet \text{ for Depth Invariance } \text{irf}_\theta(I, \mathbf{x}) = d_I \left(\mathbf{x} + \frac{\mathbf{u}}{d_I(\mathbf{x})} \right) - d_I \left(\mathbf{x} + \frac{\mathbf{v}}{d_I(\mathbf{x})} \right)$$

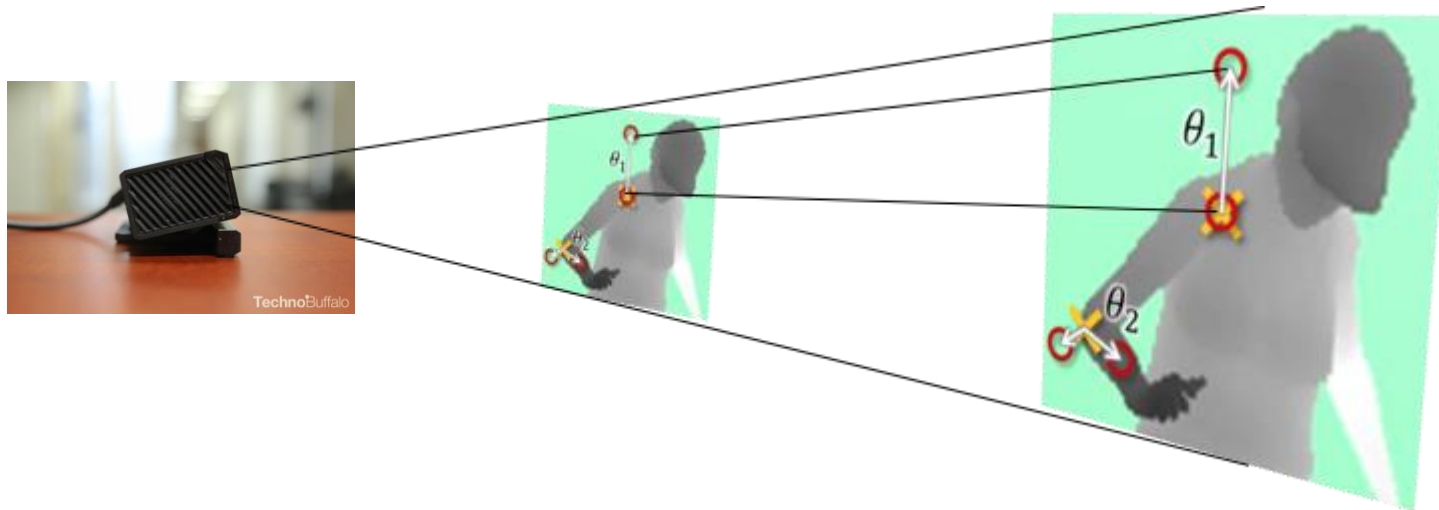

Joint Position Proposal

- **Find mode** using mean shift algorithm
 - With weighted Gaussian kernel
 - Using class probabilities for each pixel, find **representative positions** of classes



**Estimate body
joint positions**

Mean shift algorithm

Try to find *modes* of a non-parametric density.

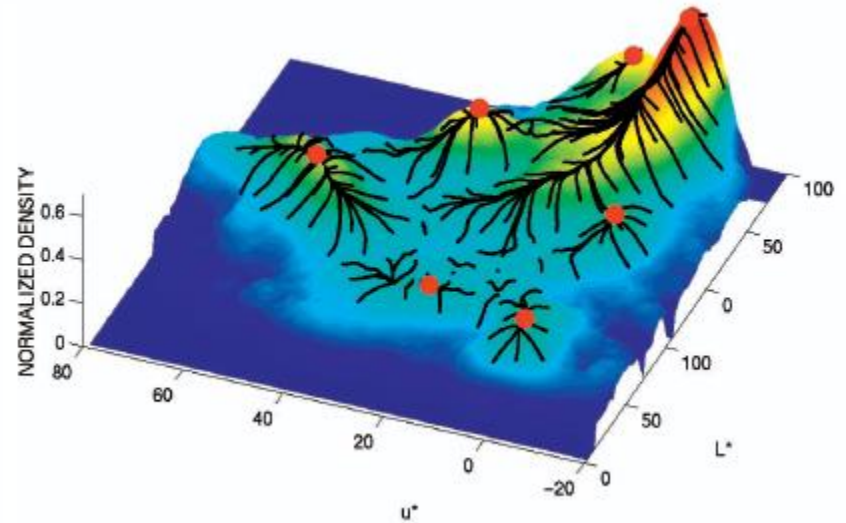

Color
space

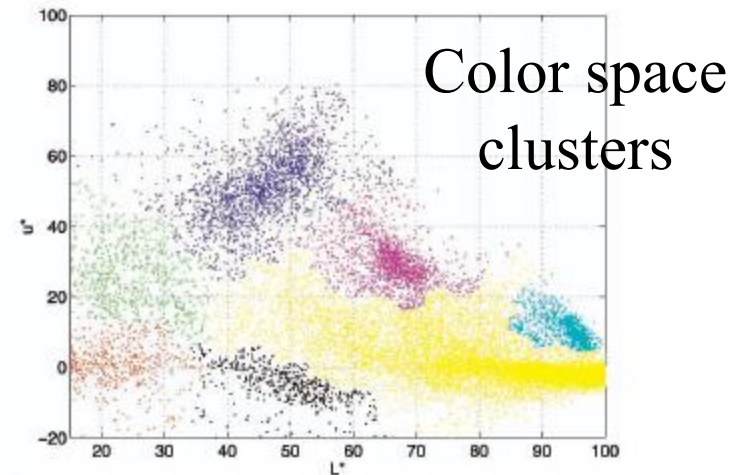
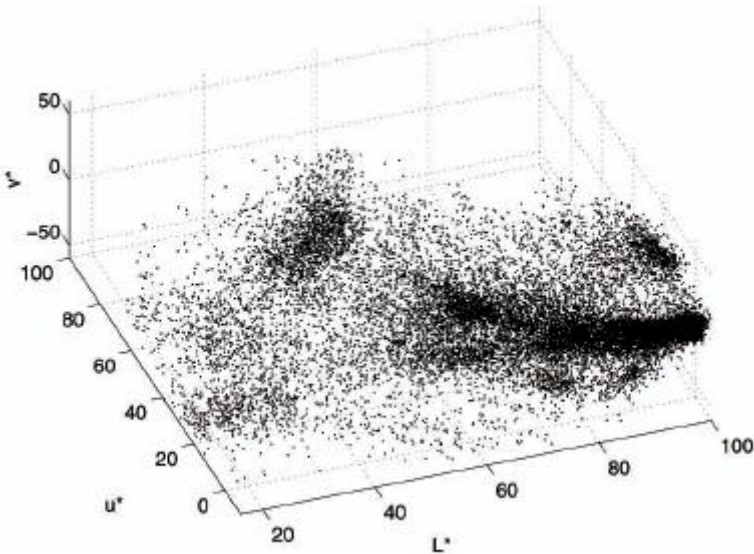

Mean shift

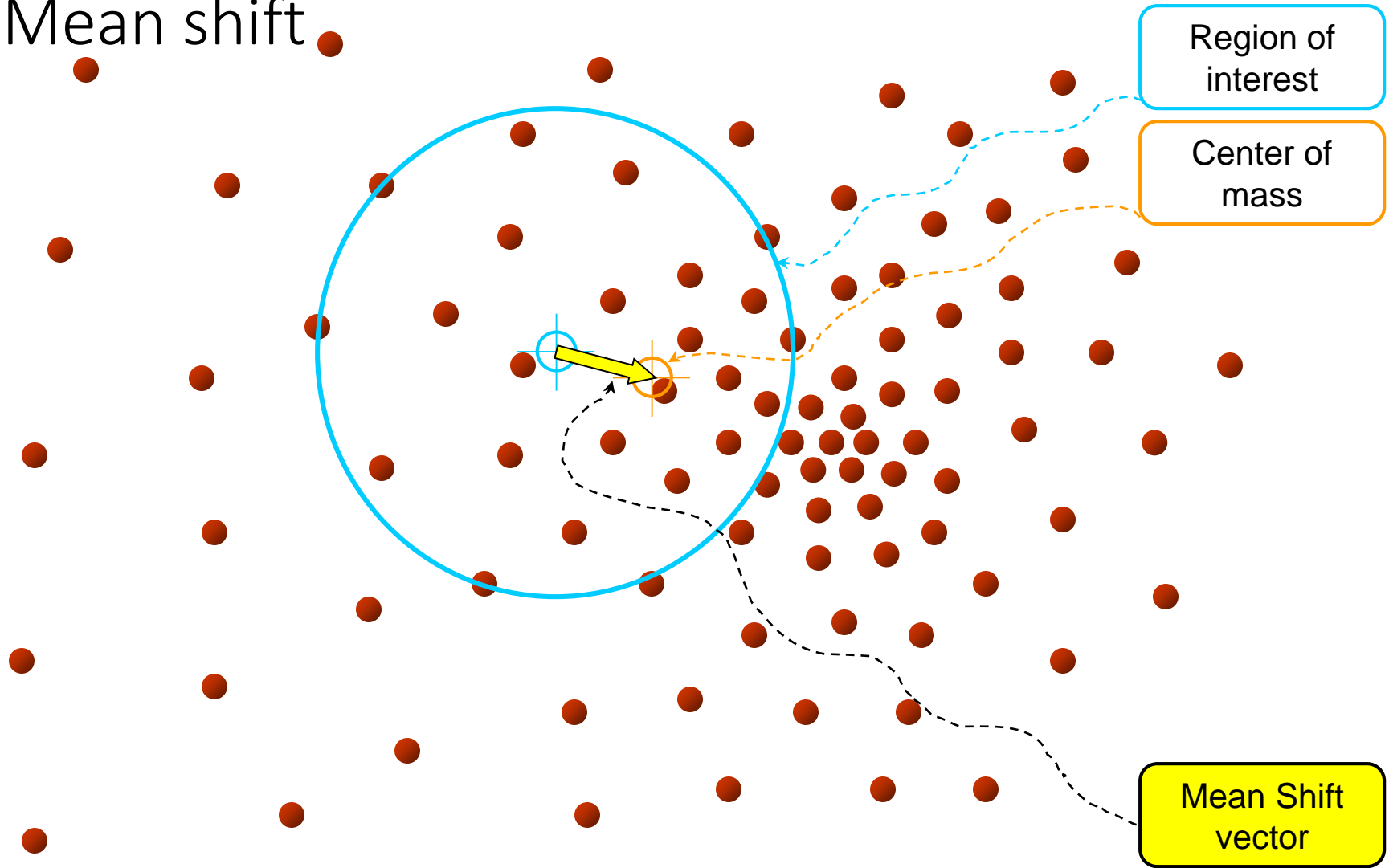

Mean shift

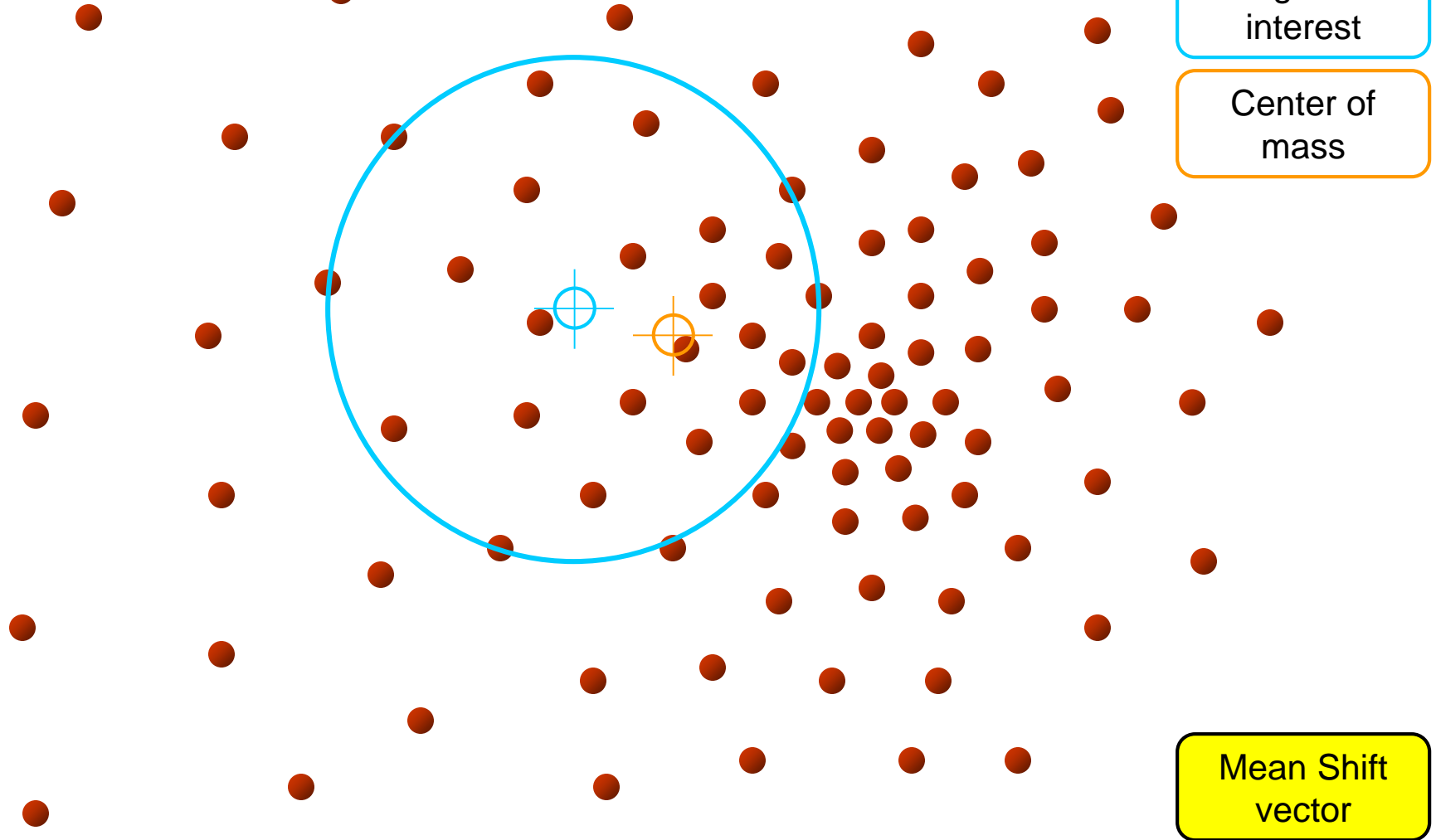

Mean shift

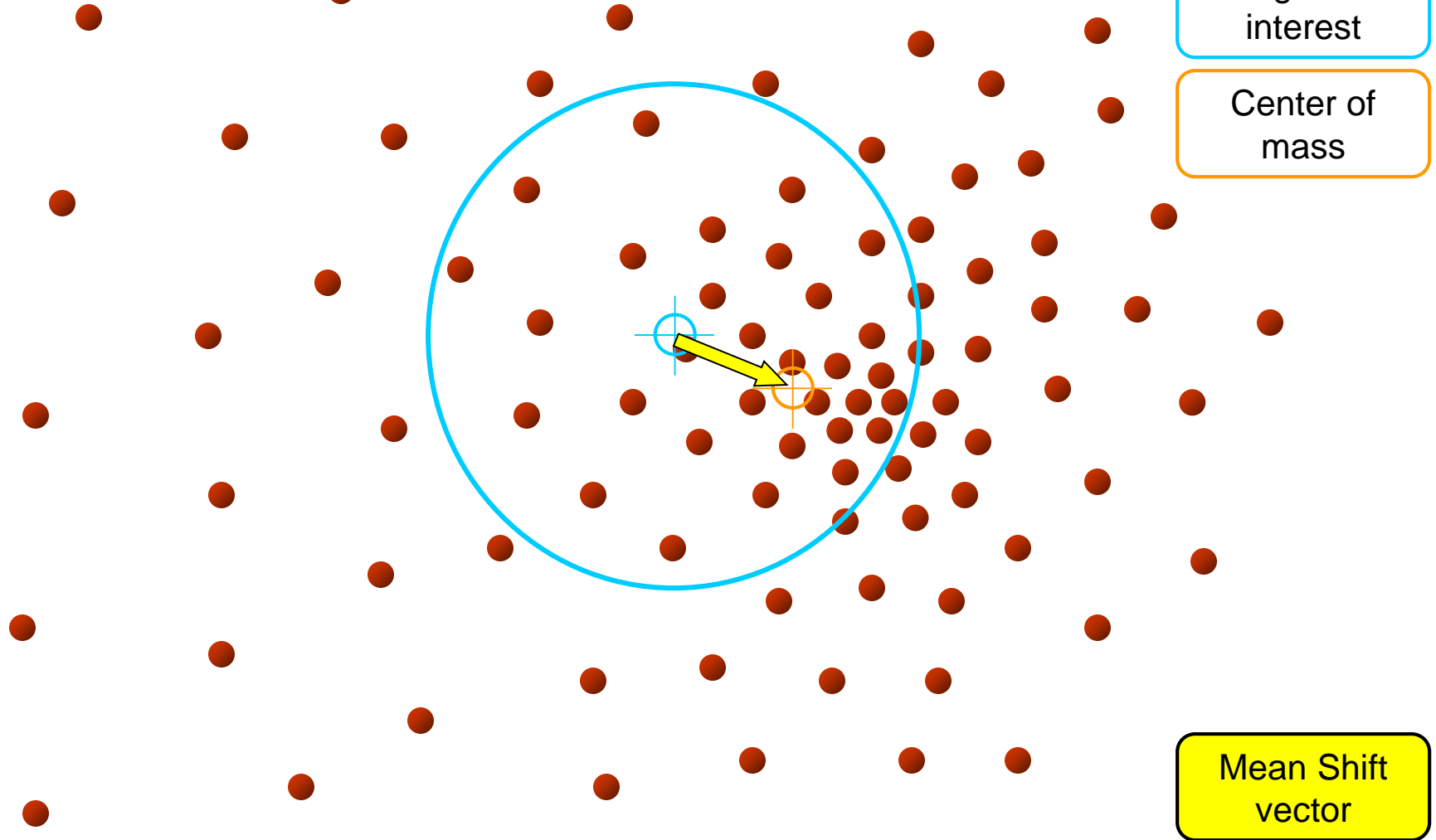

Mean shift

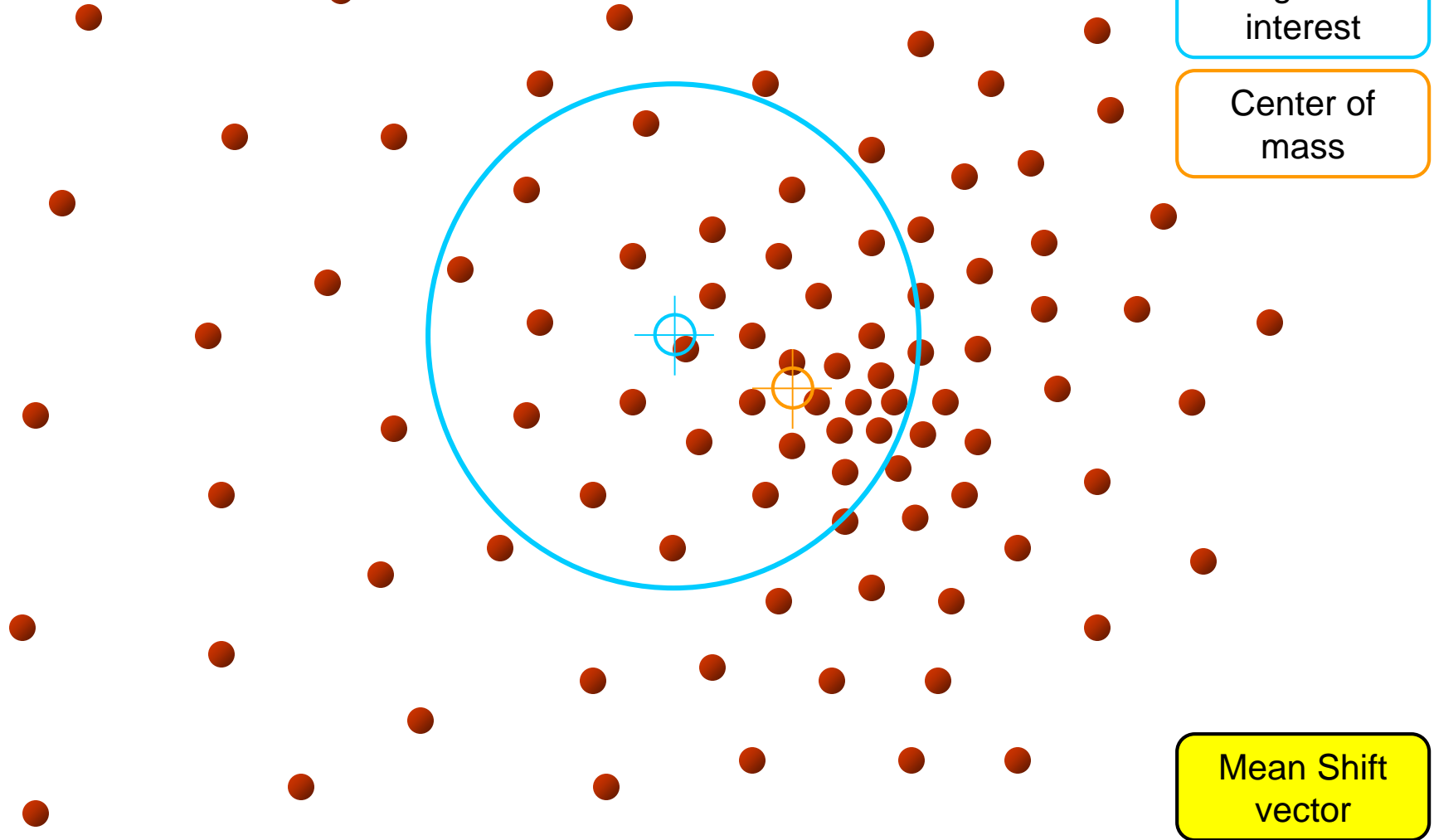

Mean shift

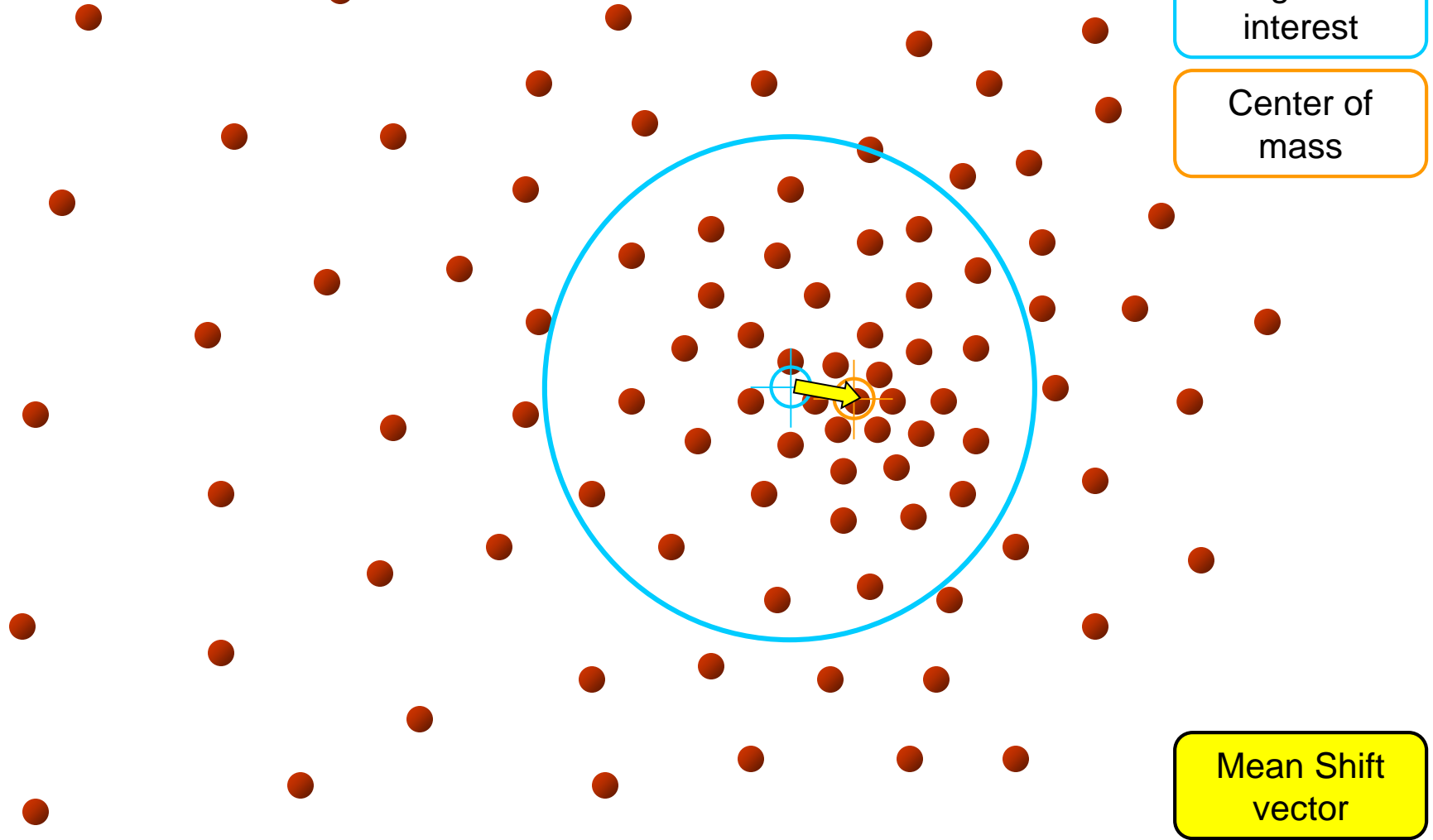

Mean shift

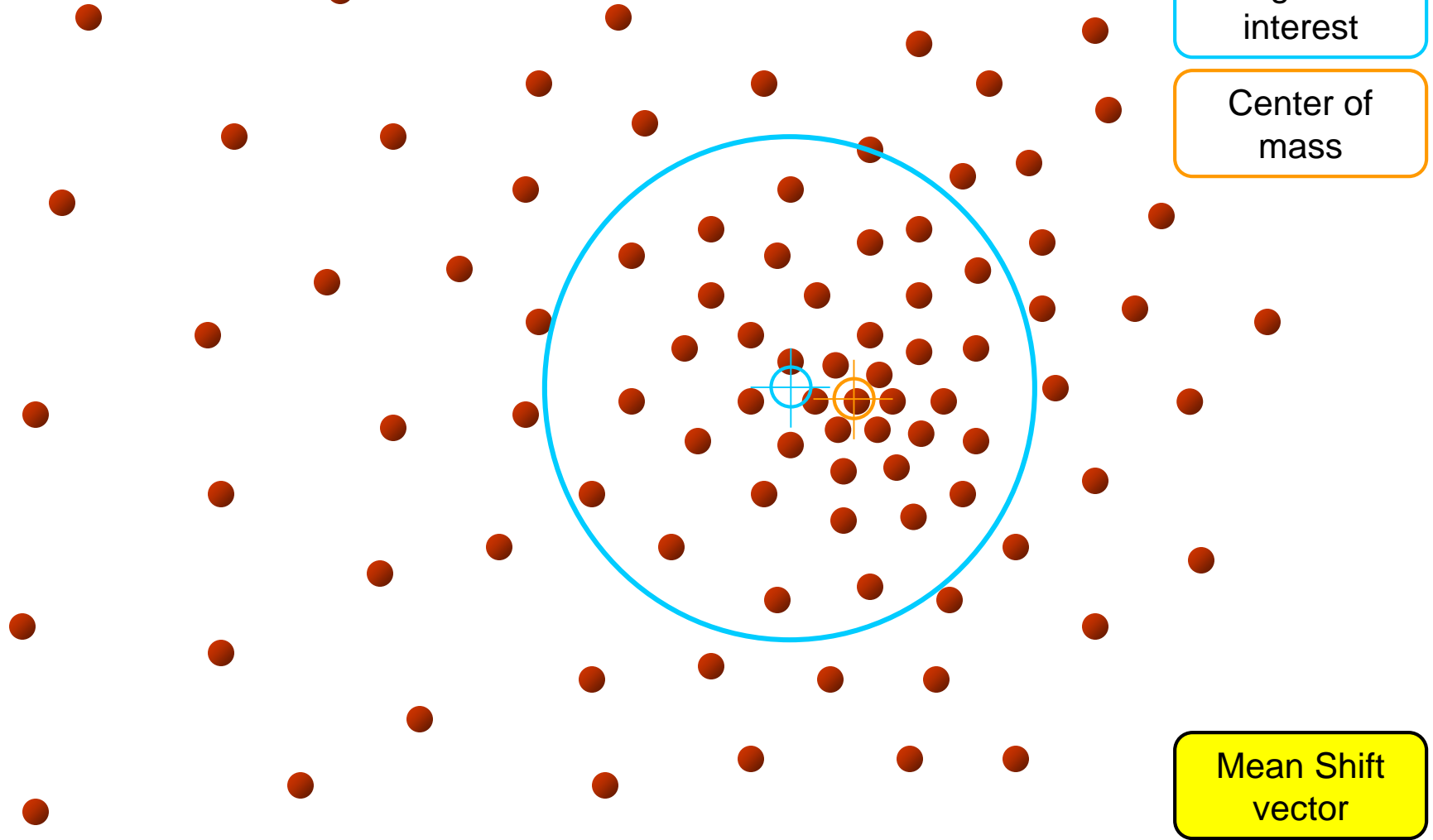

Mean shift

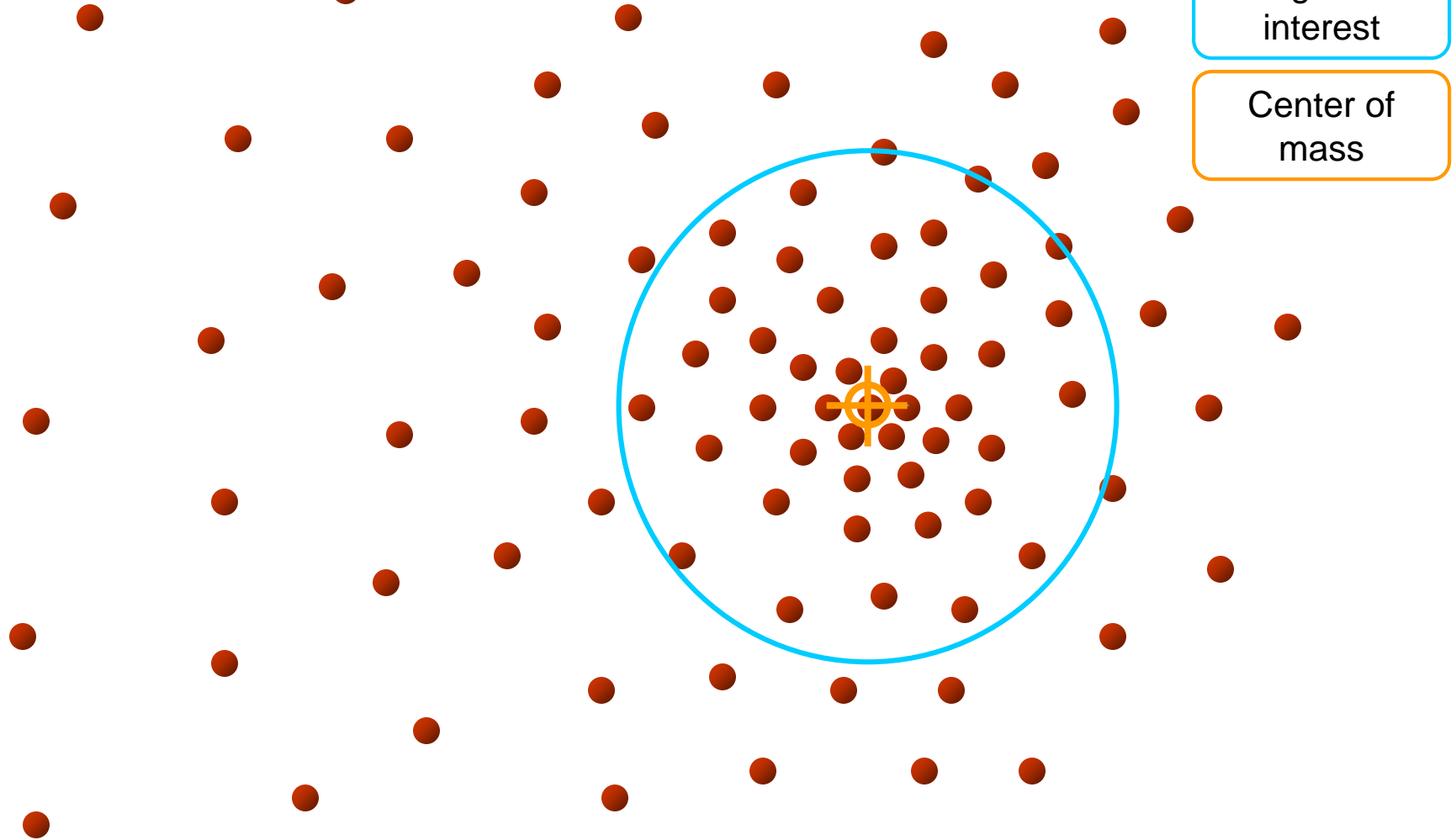

Kernel density estimation

Kernel density estimation function

$$\hat{f}_h(x) = \frac{1}{nh} \sum_{i=1}^n K\left(\frac{x - x_i}{h}\right)$$

n = number of points assessed

h = 'bandwidth', or normalization for size of region

Gaussian kernel

$$K\left(\frac{x - x_i}{h}\right) = \frac{1}{\sqrt{2\pi}} e^{-\frac{(x - x_i)^2}{2h^2}}.$$

Mean shift clustering

The mean shift algorithm seeks *modes* of the given set of points

1. Choose kernel and bandwidth
2. For each point:
 - a) Center a window on that point
 - b) Compute the mean of the data in the search window
 - c) Center the search window at the new mean location
 - d) Repeat (b,c) until convergence
3. Assign points that lead to nearby modes to the same cluster

Joint Position Proposal

- **Find mode** using mean shift algorithm
 - With weighted Gaussian kernel
 - Using class probabilities for each pixel, find **representative positions** of classes

$$f_c(\hat{\mathbf{x}}) \propto \sum_{\substack{\text{pixel index } i \\ i=1}}^N \underbrace{w_{ic}}_{\text{pixel weight}} \exp \left(- \underbrace{\left\| \frac{\hat{\mathbf{x}} - \hat{\mathbf{x}}_i}{b_c} \right\|^2}_{\text{bandwidth}} \right)$$

3D position of class
3D position of i pixel

$$w_{ic} = \underbrace{P(c|I, \mathbf{x}_i)}_{\text{class probability}} \cdot \underbrace{d_I(\mathbf{x}_i)^2}_{\text{depth at i pixel}}$$



Estimate body joint positions

Results

- **Fast Joint Proposals**

- **Max. 200 FPS on Xbox 360 GPU, 50 FPS on 8 core CPU**
 - Previous work was 4 ~ 16FPS

**Input depth image
(background segmented)**



**Inferred
body parts**



**Front
view**

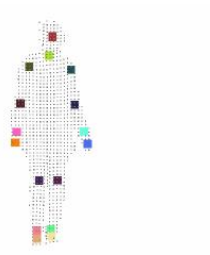

**Side
view**



**Top
view**

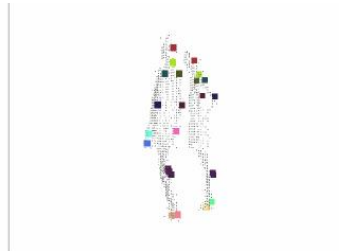
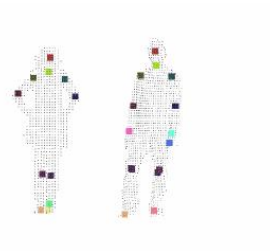
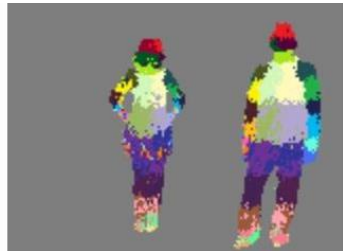

Depth of trees

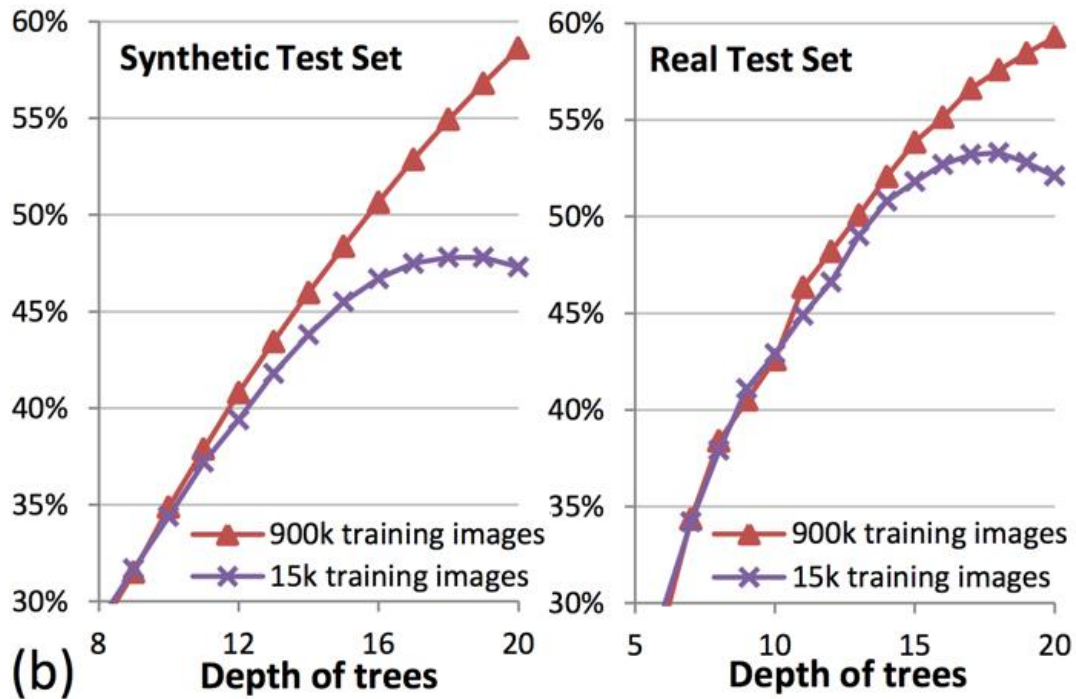

Offset Size

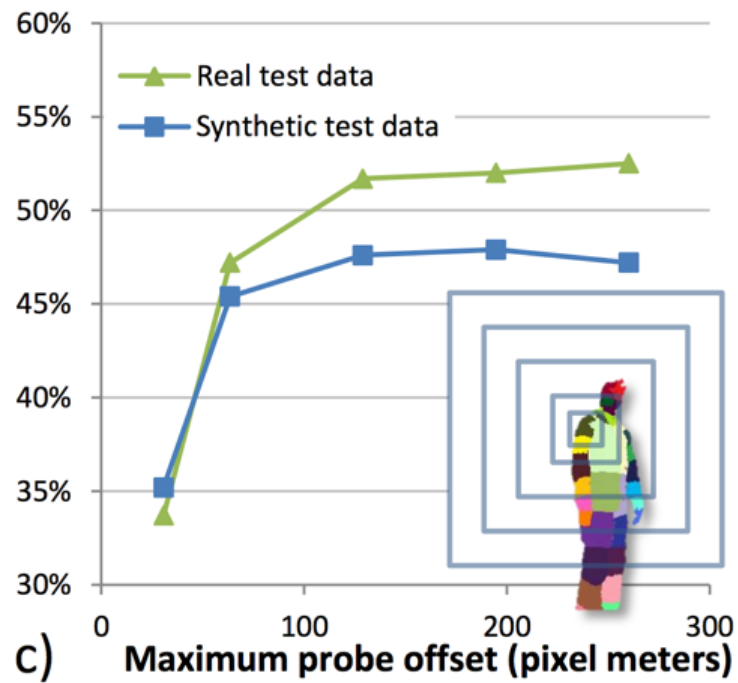

Results

- **Body Parts Classification Accuracy on synthetic test set**
 - **GT body parts (0.914 mAP) vs Our Algorithm (0.731 mAP)**

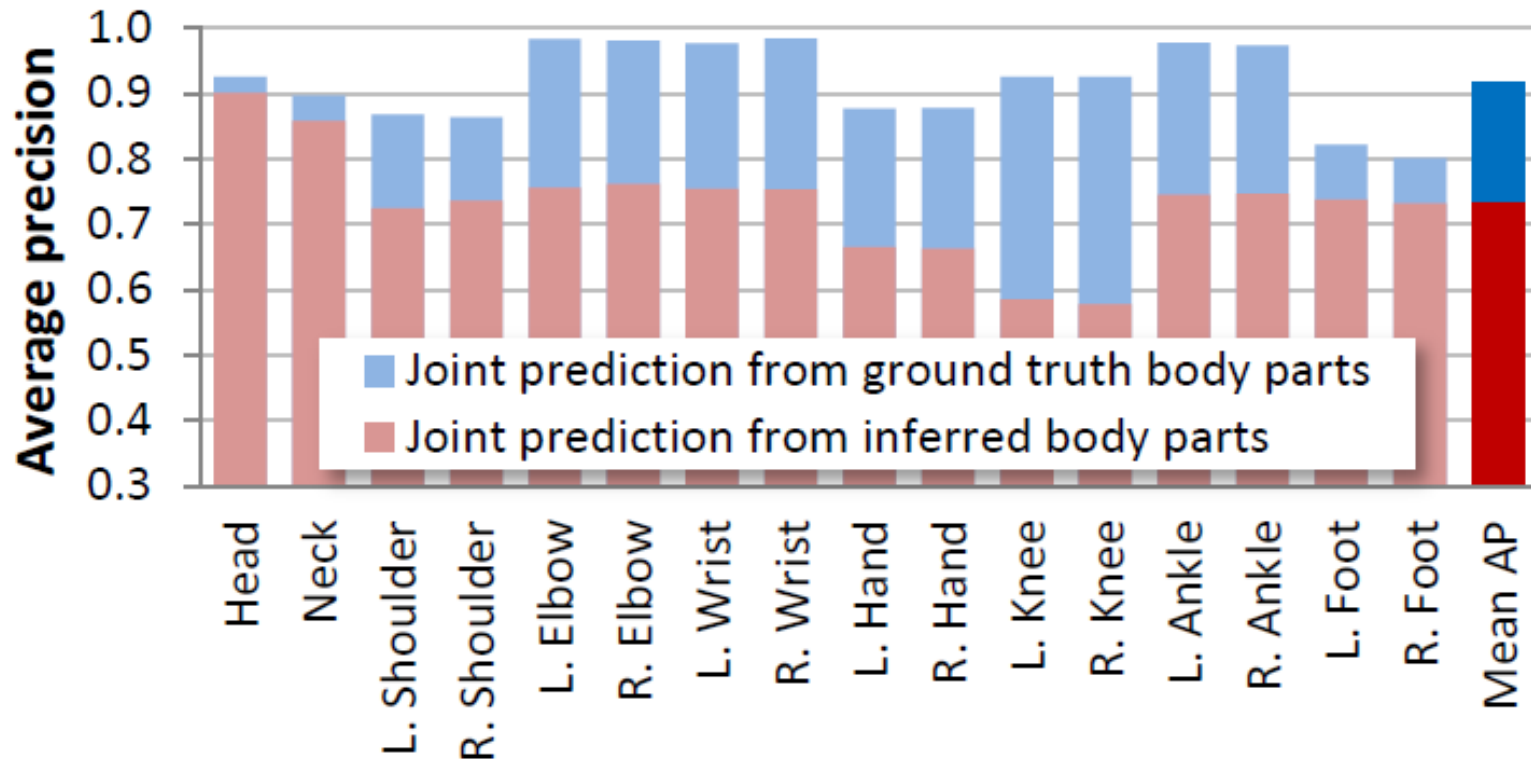

Results

- **Joint Prediction Accuracy**

- How well body joint position is predicted

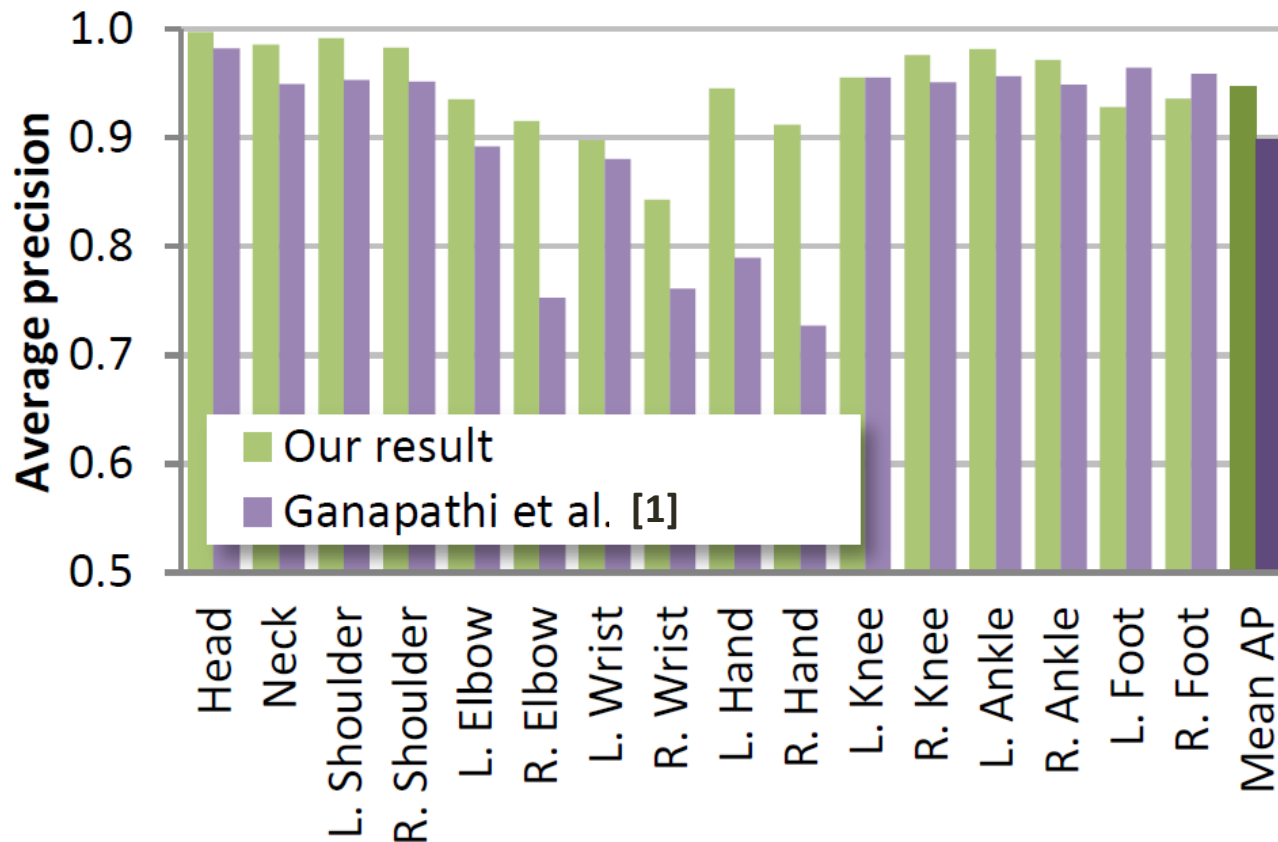

Summary

- **Body parts representation** for efficiency
- **Fast**, simple machine learning – Decision Forest
- No constraint, high **generality**
- Significant engineering to scale to a **massive, varied training dataset**

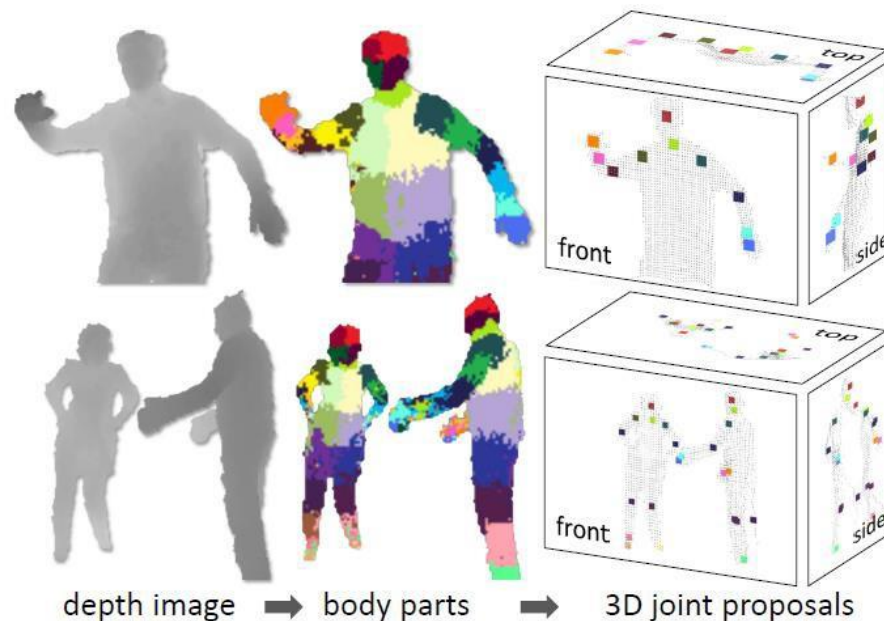

VNect – Mehta et al.

Depth information is rich...

...but do we always need it?

Can we learn to predict joint locations
from RGB data?

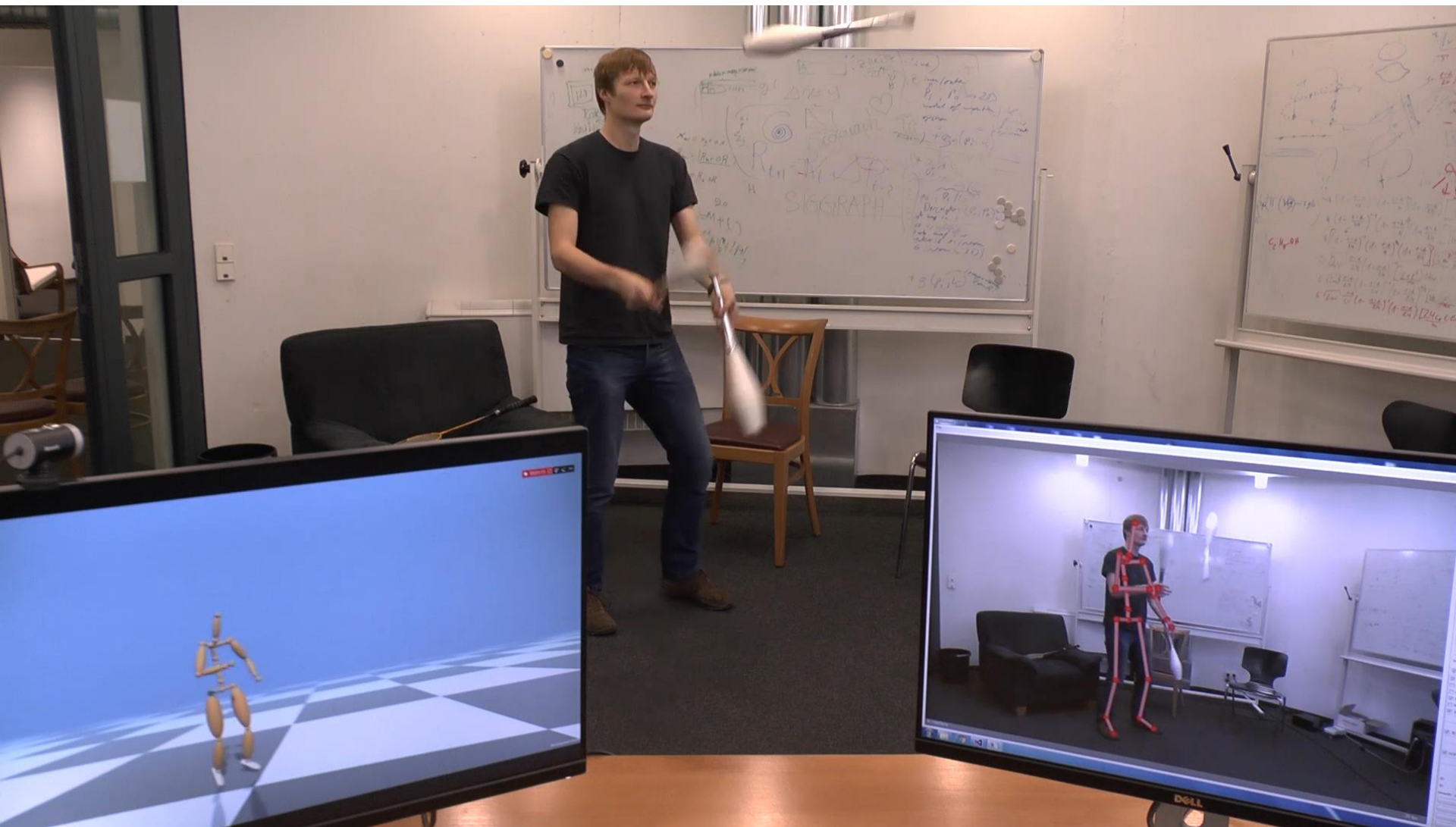

Pipeline

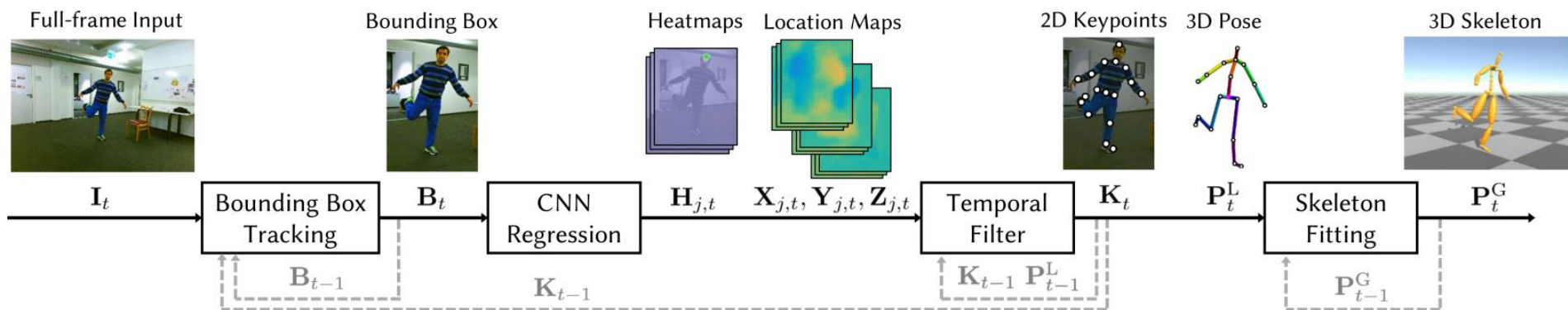

Fig. 2. Overview. Given a full-size image I_t at frame t , the person-centered crop B_t is efficiently extracted by bounding box tracking, using the previous frame's keypoints K_{t-1} . From the crop, the CNN jointly predicts 2D heatmaps $H_{j,t}$ and our novel 3D *location-maps* $X_{j,t}, Y_{j,t}$ and $Z_{j,t}$ for all joints j . The 2D keypoints K_t are retrieved from $H_{j,t}$ and, after filtering, are used to read off 3D pose P_t^L from $X_{j,t}, Y_{j,t}$ and $Z_{j,t}$. These per-frame estimates are combined to stable global pose P_t^G by skeleton fitting. Information from frame $t-1$ is marked in gray-dashed.

Joint position encoding

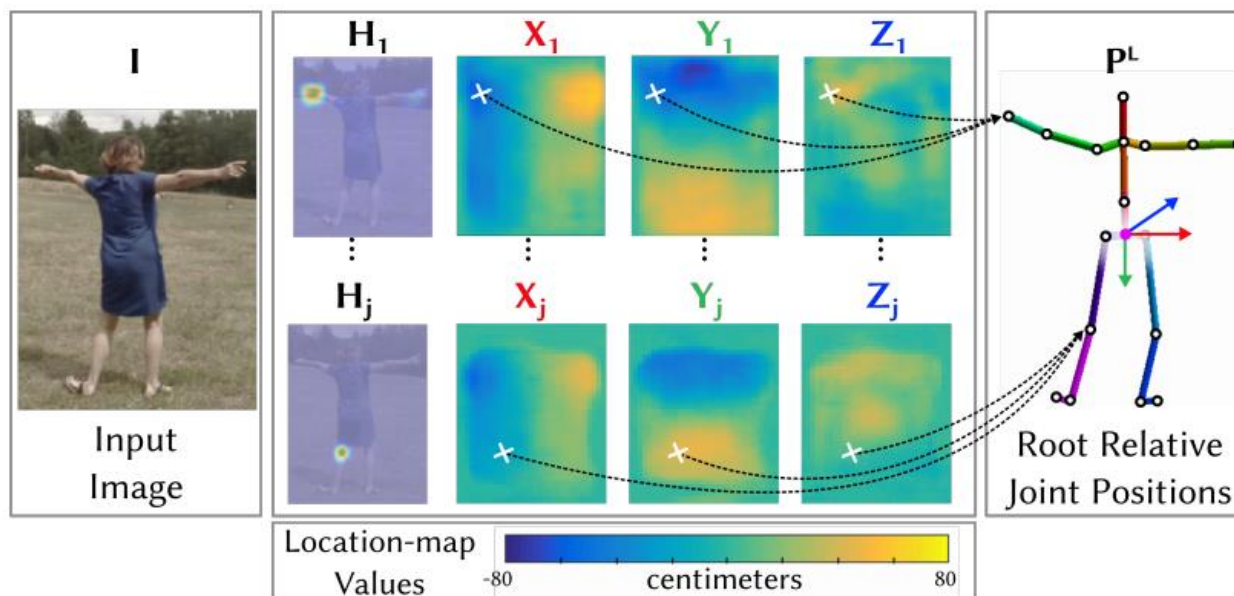

Fig. 3. Schema of the fully-convolutional formulation for predicting root relative joint locations. For each joint j , the 3D coordinates are predicted from their respective *location-maps* X_j, Y_j, Z_j at the position of the maximum in the corresponding 2D heatmap H_j . The structure observed here in the location-maps emerges due to the spatial loss formulation. See Section 4.1.

Training data



Fig. 4. Representative training frames from Human3.6m and MPI-INF-3DHP 3D pose datasets. Also shown are the background, clothing and occluder augmentations done on MPI-INF-3DHP training data.

Architecture

ResNet reminder

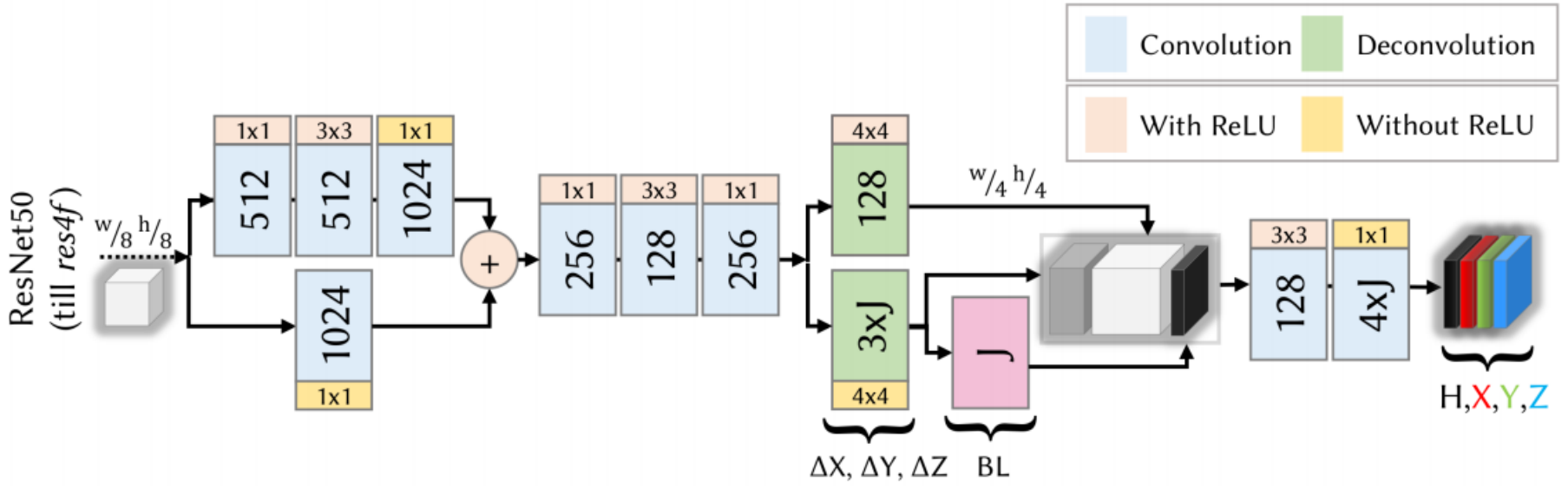
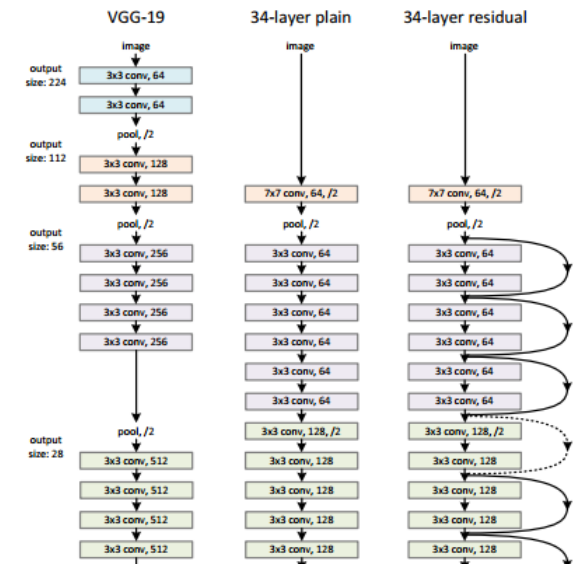
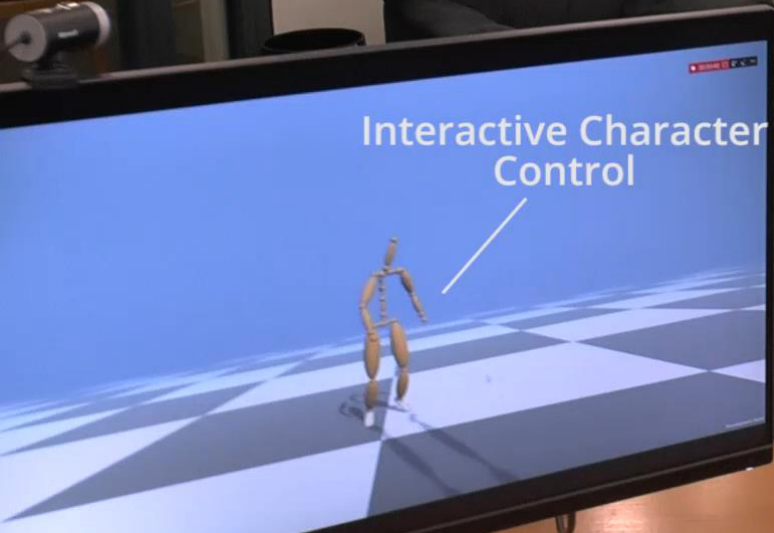

Fig. 5. Network Structure. The structure above is preceded by ResNet50/100 till level 4. We use kinematic parent relative 3D joint location predictions $\Delta X, \Delta Y, \Delta Z$ as well as bone length maps **BL** constructed from these as auxiliary tasks. The network predicts 2D location heatmaps **H** and root relative 3D joint locations **X, Y, Z**. Refer to Section 4.1.



Single Low-cost
RGB Camera



Interactive Character
Control

Real-time 3D Pose
Estimation



<http://densepose.org/>

DensePose:

Dense Human Pose Estimation In The Wild

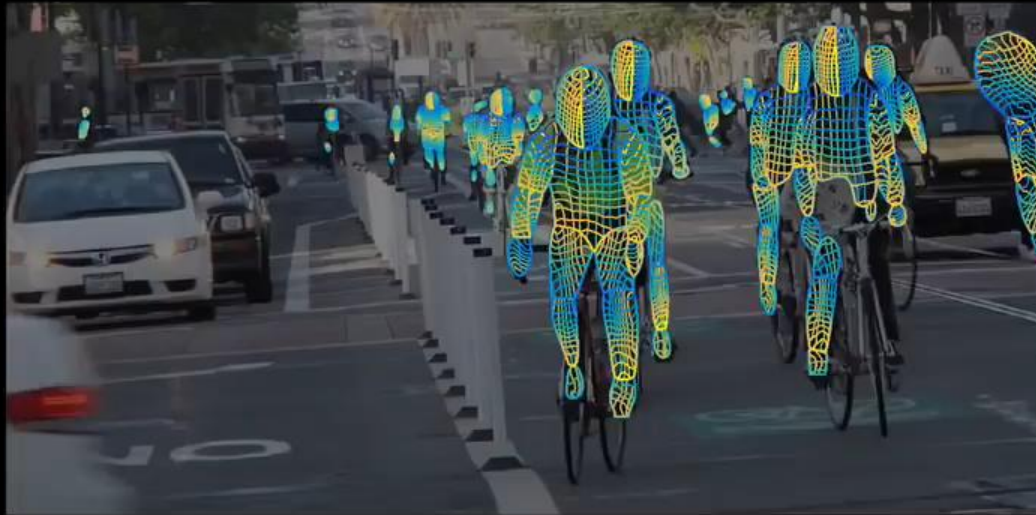

Riza Alp Güler *
INRIA, CentraleSupélec

Natalia Neverova
Facebook AI Research

Iasonas Kokkinos
Facebook AI Research

* Riza Alp Güler was with Facebook AI Research during this work.